

Applications

Sommaire des applications

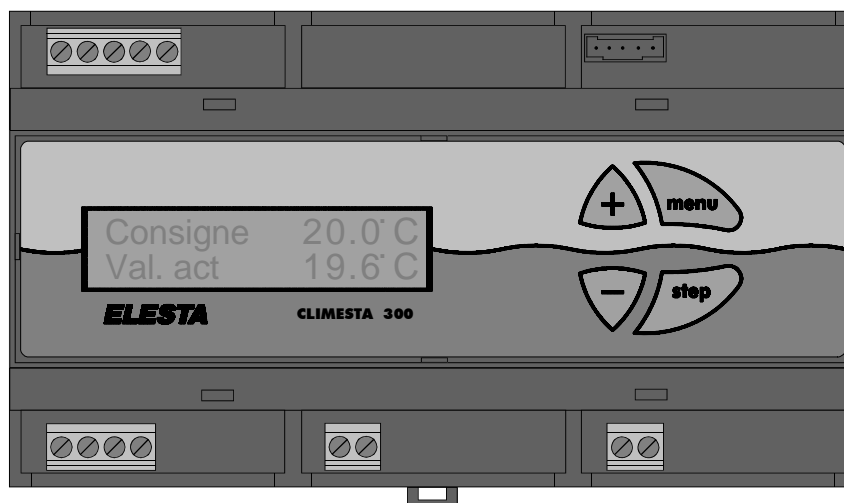

CLIMESTA RCL308A

Régulateur universel flexible

Régulation de température de l'air pulsé ou de la température ambiante, chauffage

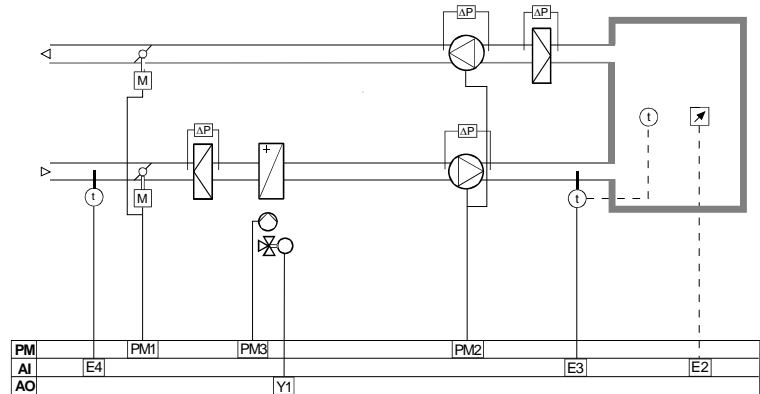

308_201V3F

Régulation cascade, chauffage-rafraîchissement

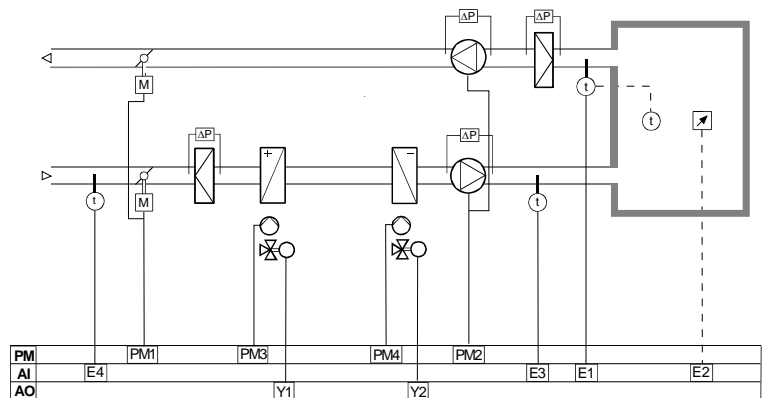

308_202V3F

Régulation cascade, chauffage-rafraîchissement-offre-demande

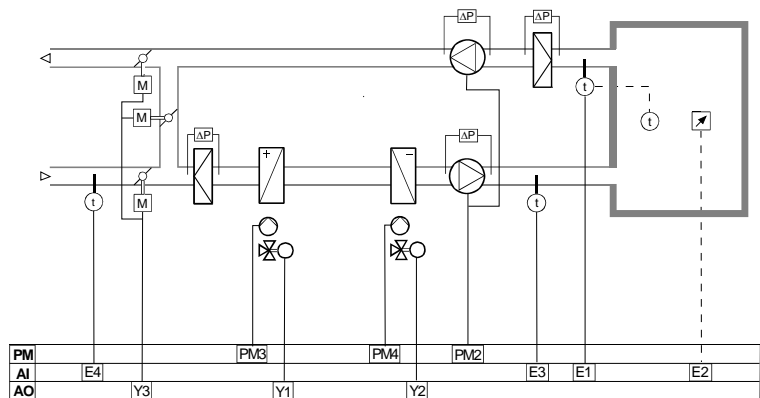

308_203V3F

Régulation cascade, chauffage-rafraîchissement-récupération d'énergie

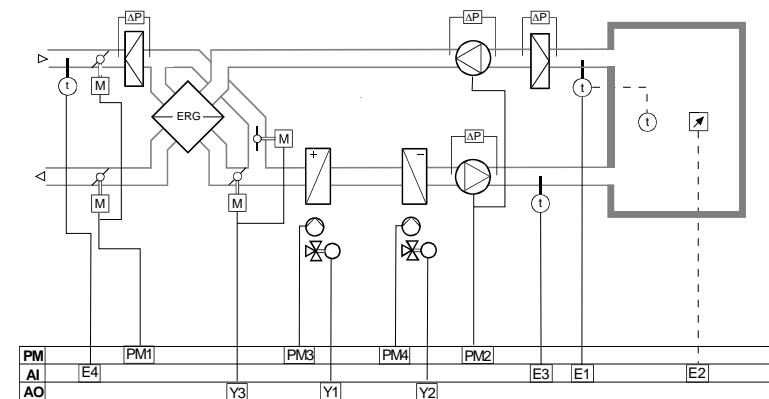

308_204V3F